

SIT CIT Test Data Approach & Plan

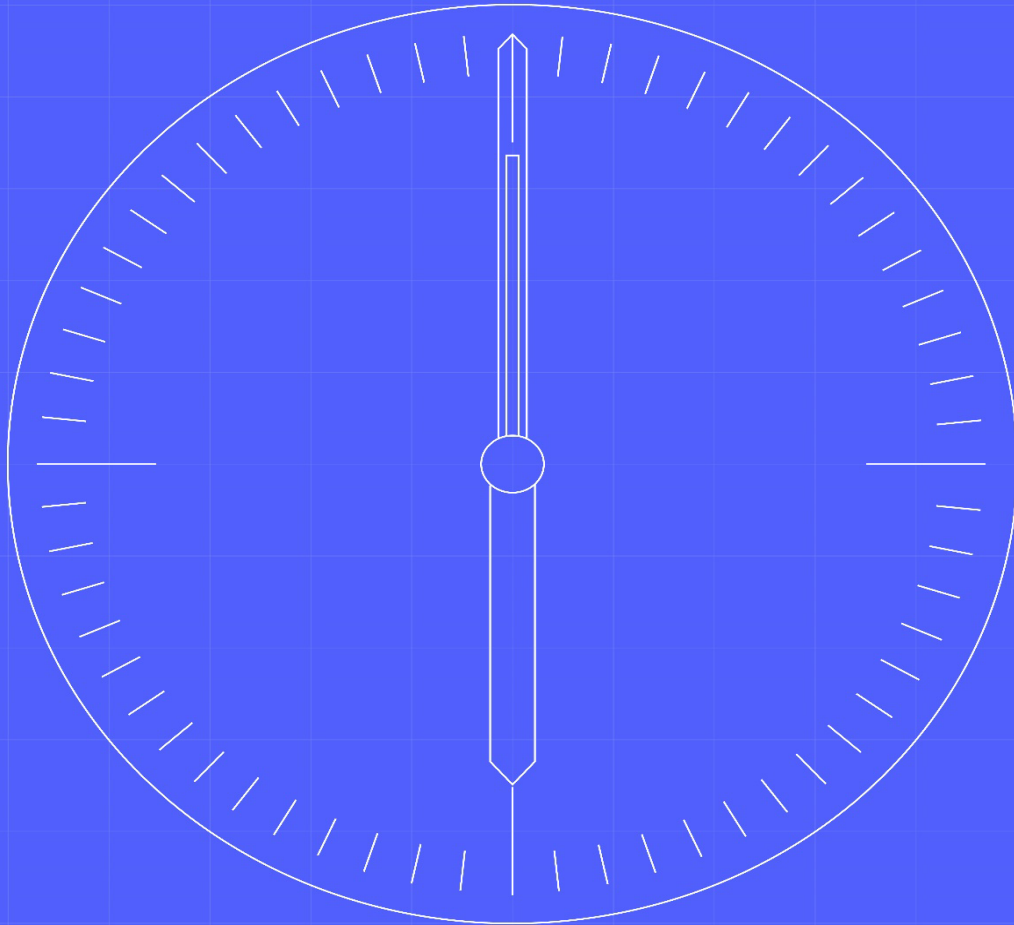

Document owner

Cesar Lopes

Status:

Approved

Document number

MHHS-DEL1309

Date

19th July 2023

Version

1.0

Classification

Public

Contents

| | | |
|-----------|--|-----------|
| 1.1 | Change Record | 3 |
| 1.2 | Reviewers | 3 |
| 1.3 | References | 3 |
| 1.4 | Terminology | 3 |
| 2 | Executive Summary | 4 |
| 3 | Introduction | 5 |
| 3.1 | Document Purpose | 5 |
| 3.2 | Reviews and Approvals | 5 |
| 3.3 | Change Forecast | 5 |
| 3.4 | Summary of Changes | 5 |
| 3.5 | Assumptions and Caveats | 6 |
| 3.5.1 | Assumptions | 6 |
| 3.5.2 | Caveats | 6 |
| 4 | Objectives | 6 |
| 4.1 | Objectives | 6 |
| 5 | Scope | 6 |
| 5.1 | In Scope | 6 |
| 5.2 | Out of Scope | 6 |
| 6 | Test Architecture & Coverage | 7 |
| 6.1 | MHHS Architecture and Coverage | 7 |
| 7 | Test Data Approach | 8 |
| 7.1 | Test Intervals | 8 |
| 7.2 | Test Data Allocation | 8 |
| 7.3 | Test Data Approach – Receiving PUB | 9 |
| 7.4 | Test Data Approach – Generating IF Scenarios | 10 |
| 7.5 | Test Data Approach – PUB messages trigger IF | 10 |
| 7.6 | Test Data Preparation - Interval 1 - BSC Central Services (LSS, MDS) | 11 |
| 7.7 | Test Data Preparation – Intervals 2 and 6 – MPRS | 12 |
| 7.8 | Test Data Preparation - Interval 3 – SDS and ADS | 15 |
| 7.9 | Test Data Preparation - Interval 4 – Metering Services | 16 |
| 7.10 | Test Data Preparation - Interval 5 – Suppliers, LDSO and UMSO | 16 |
| 7.11 | Test Data Preparation - Interval 6 – UMSDS, EES | 18 |
| 8 | Test Data Anonymisation | 19 |
| 8.1 | Test Data Anonymisation for Testing Reports and Test Evidence | 19 |
| 9 | Test Data Schedule | 20 |
| 10 | Appendix | 21 |

Figures

| | |
|---|----|
| Figure 1 – TOM illustration (Note CIT DIP interface scope within red box) | 7 |
| Figure 2 – CIT Intervals | 8 |
| Figure 3 – Test Data Scenario – Receiving PUB | 9 |
| Figure 4 – Test Data Scenario – Participant's system starts the test | 10 |
| Figure 5 – Test Scenario – Responding to PUB | 11 |
| Figure 6 – ISD IF-047- Broadcast | 12 |
| Figure 7 – MPAN obfuscation for Test Reports and evidence | 19 |
| Figure 8 – SIT CIT Test Data Intervals | 20 |
| Figure 9 – SIT CIT Test Data Intervals – Detailed View | 21 |

1.1 Change Record

| Date | Author(s) | Version | Change Detail |
|------------|-------------|---------|---|
| 05/06/2023 | Cesar Lopes | 0.1 | Initial Draft |
| 09/06/2023 | Cesar Lopes | 0.2 | Updated following SRO review |
| 28/06/2023 | Cesar Lopes | 0.3 | Updated following Industry Consultation |
| 13/07/2023 | Cesar Lopes | 0.4 | Updated following Assurance Review |
| 18/07/2023 | Cesar Lopes | 0.5 | Updated to include Network Operations as a sender of IF-020 message |
| 19/07/2023 | Cesar Lopes | 1.0 | Baselined at v1.0 following July TMAG approval |

1.2 Reviewers

| Reviewer | Role |
|------------------|--------------------------------------|
| Lee Cox | SI Test Manager |
| Kevin Davis | SI Test Architect |
| Cesar Lopez | SI Data Architect |
| Simon Berry | SI Environments and Release Manager |
| Adrian Ackroyd | SRO Function Programme Test Manager |
| Smitha Pichrikat | SRO Function Client Delivery Manager |

1.3 References

| Ref No. | Document/Link | Publisher | Published | Additional Information |
|---------|--|------------|-----------------------------|------------------------|
| REF-01 | MHHS E2E Testing & Integration Strategy | SI Testing | 29 th April 2022 | |
| REF-02 | MHHS-DEL1258 SIT Component Integration Testing Approach & Plan | SI Testing | 8 th June 2023 | |
| REF-03 | MHHS-DEL 300 Test Data Strategy | SI Testing | 18 th May 2023 | |
| REF-04 | MHHS-DEL813 Overarching Test Data Approach & Plan | SI Testing | 24 th May 2023 | |
| REF-05 | MHHS-DEL1166 SIT CIT Test Scenarios | SI Testing | 17 th April 2023 | |
| REF-06 | MHHSP-DES138-Interface Catalogue | MHHS | February 2021 | |

1.4 Terminology

| Term | Description |
|---------|--|
| Various | For terminology, see Programme Glossary on the MHHS portal: Programme Glossary (SharePoint.com) |

2 Executive Summary

The Market-wide Half Hourly Settlement programme (MHHS) when completed will contribute to a more cost-effective electricity system, encouraging more flexible use of energy and helping consumers lower their bills.

[REF-01] MHHS E2E Testing & Integration Strategy describes the overall, end-to-end (E2E) approach to testing - the manner in which all parties involved in the MHHS programme will conduct testing. The purpose of Systems Integration Testing (SIT) phase is to prove that the component Services are implemented in a way consistent with the MHHS E2E Design and interact in a coherent and consistent manner.

The first SIT phase is:

- **Component Integration Testing (CIT)**, where all components of the MHHS E2E solution are integrated and tested for compliance with the interface specifications and codes of connection. This includes step-by-step integration of the DIP (including PKI), central systems, MPRS, Smart and Advanced Data Services, Metering Services, Suppliers, Network Operations, UMSSO services and UMSSDS.

The [REF-02] MHHS-DEL1258 SIT Component Integration Testing Approach & Plan describes the associated objectives, scope, approach, schedule, management, governance, and assurance of the SIT CIT test stage.

To support the provision of Test data for System Integration Tests, the Programme produced two high level documents:

- [REF-03] MHHS-DEL 300 Test Data Strategy: covers the data required to be co-ordinated across the systems for testing purposes
- [REF-04] MHHS-DEL813 Overarching Test Data Approach & Plan: establishes a common and fully aligned set of test data for use in the industry-wide test phases of MHHS.

This Test Data Approach and Plan document specifically relates to the Component Integration Test (CIT) stage. This is a child document of [REF-04] MHHS-DEL813 Overarching Test Data Approach & Plan and therefore it is recommended that for context both documents are read in conjunction.

3 Introduction

3.1 Document Purpose

This document aims to define a Test Data Approach specifically for the SIT Component Integration Tests. It provides a detailed view of specific data required per participant role.

This document is intended to be read by the following groups:

- SRO Function (SRO)
- Lead Delivery Partner (LDP)
- Testing and Migration Advisory Group (TMAG)
- Data Working Group (DWG)
- Programme Participant Test Managers
- All Programme party teams and resources involved in SIT execution or support.

3.2 Reviews and Approvals

The Component Integration Test Approach and Plan will go through initial LDP review by the following team members:

- Lee Cox, SI Test Manager
- Kevin Davis, SI Test Architect
- Simon Berry, SI Environments and Release Manager
- John Wiggins, LDP Transition/Migration Lead

Upon completion of LDP review, any comments and feedback would be incorporated before going to the SRO team formal review by:

- Ian Smith, SRO Design Lead
- Smitha Pichrikat, SRO Function Client Delivery Manager

Upon completion of the SRO review it will then be distributed to the DWG for review where comments will be incorporated leading to a recommendation of approval by the group.

When comments and feedback have been incorporated, approval will be requested from:

- Testing and Migration Advisory Group (TMAG).

The document will be made available for information via the programme portal.

3.3 Change Forecast

The SI team will own this document and keep it up to date, with review and approval by MHHS programme governance as appropriate. Each new version supersedes the previous version in its entirety.

Updates to this document will follow the review and approval process outlined in section 3.2.

3.4 Summary of Changes

Document updated in the version 0.5 following Industry Assurance Review:

- Section 7.6: Removed VAS and Settlement Operations from scope.
- Section 7.10:
 - Table 8 to update the UMSO IF messages.
 - Added Table 9 to include LDSO as a sender of IF-020.
- Section 7.11:
 - Updated EES test data preparation for CIT – No data refresh from MPRS.
 - Updated UDSS IF messages
- Section 8: Data anonymisation – Added more details, including approach for Reports.

3.5 Assumptions and Caveats

3.5.1 Assumptions

- At the time of writing this document assumes that the Re-plan CR022 is approved by Programme Steering Board and the MHHS programme plan will be baselined.

3.5.2 Caveats

N/A.

4 Objectives

4.1 Objectives

The objective of the Component Integration Testing (CIT) stage is to demonstrate that each Market role in scope, which directly integrates with the DIP, can bi-laterally interface with the DIP successfully, and the DIP can then route interface messages to the correct recipients based on IF message sender and payload conditions.

The objective of this document is to establish the approach to obtain the test data required to execute and pass all test scenarios / cases in the scope of the Test Stage without exception.

5 Scope

5.1 In Scope

As described in [REF-02] MHHS-DEL1258 SIT Component Integration Testing Approach & Plan, the scope of SIT Component Integration is:

1. For all Roles interfacing with the DIP:
 - I. **Verify ability to download the Industry Standing Data** for each Participant within MHHS Architecture:
 - II. **Verify ability to send/receive IF/PUB** for each individual Participant within MHHS Architecture:
2. For the DIP:
 - i. **Verify DIP routing**

Please refer to [REF-05] 'SIT CIT Test Scenarios' for further detail of the CIT coverage.

5.2 Out of Scope

As per [REF-02] MHHS-DEL1258 SIT Component Integration Testing Approach & Plan, it is out of scope for testing:

- Only direct interfaces with the DIP will be tested in CIT
 - The non-DIP direct interfacing roles i.e. DCC (DSP, CSS, EES), VAS, National Grid ESO and DTN, will be introduced within a connectivity proving stage prior to SIT Functional Test stage.

- DCC UEPT – Participants adopting the SDS MDR role are to engage with the DCC and follow and complete the associated User Entry Process Test procedures as a pre-requisite to entering SIT Test. (Note this does not apply to suppliers fulfilling the MDR role using IS and ES IDs).

This document does not also cover the details of provisioning of data for:

- All the other SIT Stages – these will be the subject of separate Test Data Approach and Plan documents:
 - Functional Test
 - Migration Test
 - Non-Functional Test
 - Operational Test
- UIT Test Stages:
 - Qualification Test
 - E2E Sandbox

6 Test Architecture & Coverage

6.1 MHHS Architecture and Coverage

Component systems/services will be integrated one at a time or in small groups over six intervals within the CIT test window. Testing and Testing Data will focus on each role/service that directly integrates with Data Integration Platform (DIP) see Figure 1 below.

Test scenarios and cases for CIT have been designed to be conducted on a bi-lateral basis between each role/service and the DIP only, i.e. there will be no dependency on the involvement of other roles/services within in the architecture in order to complete the tests in scope for this stage.

Tests will then be conducted based on the IF/PUB messages relevant to each role in scope.

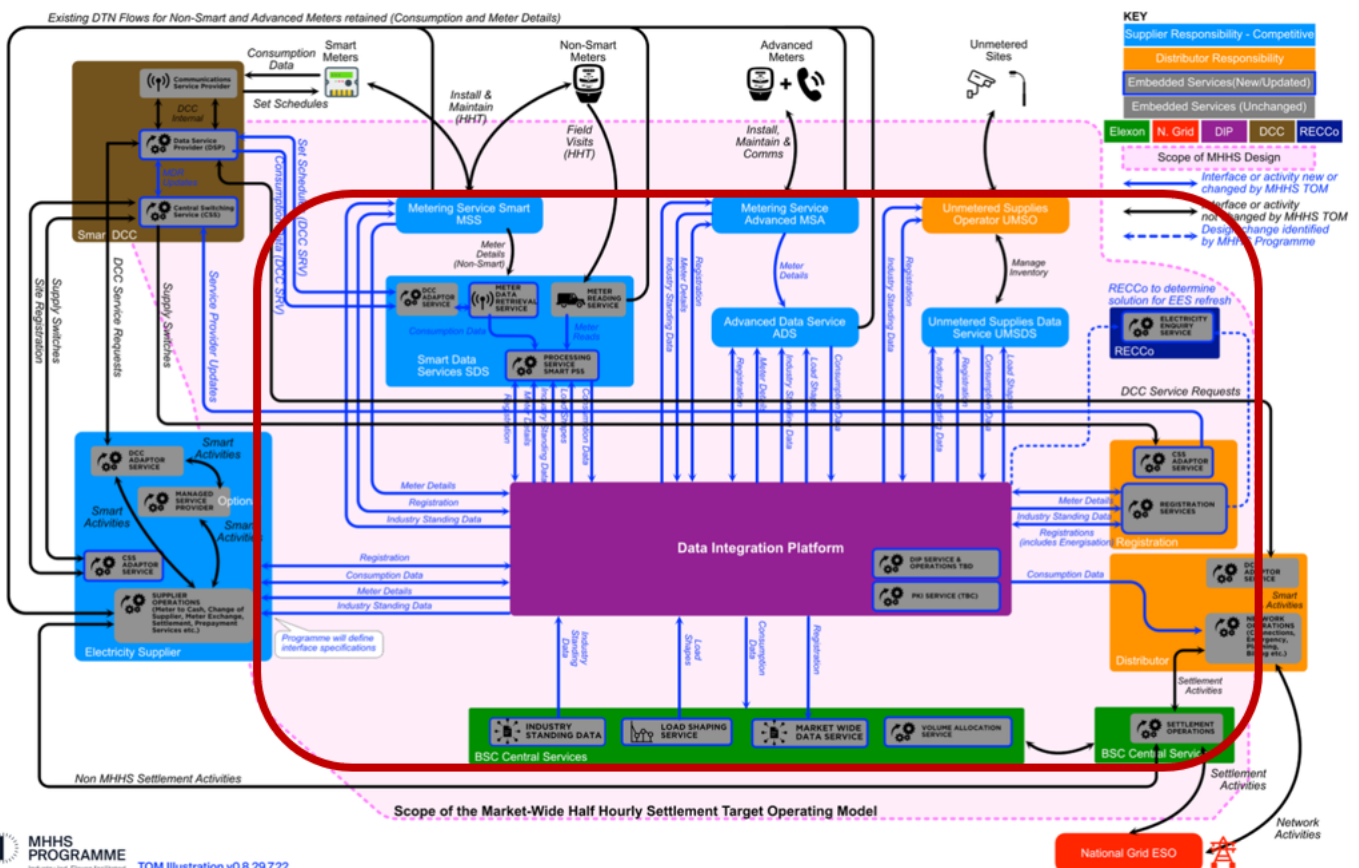

MHHS PROGRAMME
Industry-led, Elexon facilitated
TOM Illustration v0.8 29.7.22

Figure 1 – TOM illustration (Note CIT DIP interface scope within red box)

Each role/service will be expected to receive and to send one example of each IF/PUB message relevant to it in order for that service to pass SIT CIT.

The following combination of data items makes each scenario unique:

- Interface (IF number)
- Event Code
- Data Conditions
- Sender

Notes:

1. The interface (IF number) is fully documented on [REF-06] MHHSP-DES138-Interface Catalogue. All Mandatory data items per test scenario shall be obtained from there, including details of data type, enumerations and format.
2. Data Conditions means any specific conditions called out in the MHHSP-DES138-Interface Catalogue which are used to determine the routing. For example, routing for an IF-006 can depend on the Supply Start Date.
3. During CIT, tests will also be required to show the DIP routing of, and participants systems’ ability to download the Industry Standing Data (ISD).

For details of the scenario coverage, please refer to [REF-05] ‘MHHS-DEL1166 SIT CIT Test Scenarios’.

7 Test Data Approach

7.1 Test Intervals

The approach to CIT will be to progressively onboard participants based on role / service in a controlled sequence, thus allowing confidence to be increased as each system / service joins and completes testing.

For more details and timeline, see [REF-02] MHHS-DEL1258 SIT Component Integration Testing Approach & Plan.



SIT CIT Progressive Integration

- Participants progressively onboarded by system / role
- PIT and SIT readiness aligned to CIT entry point

| SIT CIT Entry Interval | Systems / Services |
|------------------------|---|
| 1 | DIP, LSS, MDS |
| 2 | MPRS (Drop 1) |
| 3 | Smart Data Services, Advanced Data Services |
| 4 | Metering Services |
| 5 | Suppliers, Network Operations, UMSO |
| 6 | MPRS (Drop 2), EES, UMSDS |

Figure 2 – CIT Intervals

NOTE: CIT will evaluate the DIP interfaces integration and routing. It won’t evaluate the functional processing of the messages.

7.2 Test Data Allocation

1. For each CIT Test Scenario, the SI Test Lead will allocate a minimum of **20 MPANs** with the required data conditions.

- If any participant requires more than 20 MPANs to cover test and re-testing of specific Test Scenarios, the SI Test Lead will work with the participant to address the need and provide all additional MPANs.
2. The SI Test Lead will identify and allocate suitable data considering the participant's own data cut.
 3. Some of the DIP message routing rules depend on MPAN, Market Participant ID and DIP ID. The SI Data Lead will allocate the MPANs accordingly.
 4. When suitable data is not available from the Participant's own data cut, the SI Data Lead will re-allocate data from another participant with a bigger dataset.
 - It is the participant's responsibility to load the allocated test data to their environment.
 - Participants may re-use the mechanisms adopted to load test data for PIT.
 - Whenever possible, any data reallocation should use business-as-usual routines to avoid database corruption.
 - It is not possible for MPANs to be reallocated between DNOs/iDNOs. The MPAN prefix is fixed. In this case, the test will have to be conducted through the other DNO/iDNO instance.
 - No real consumption history for a given MPAN will be shared. Anonymised consumption will be used (emulated or randomly copied from another MPAN).
 5. Participants won't be required to return the MPANs state to values prior to execution of the test. If a test invalidates an MPAN condition, the MPAN won't be used in subsequent test cases and test phases (eg: SIT Functional Tests)
 6. The test data allocation and its load into the test environments will be executed before the start of the participant CIT Interval. See Figure 9 for details on when the Test Allocation is planned to execute.

7.3 Test Data Approach – Receiving PUB

For Tests Scenarios checking the correctness of DIP routing and participant's systems receiving PUB messages, the SI will use data from the data cut to start the IF message. The data will need to comply with IF message mandatory fields and data conditions established by the Test Scenario/Test Cases. Figure 3 illustrates the workflow.

During the Test Data preparation before the CIT Test Intervals kick-off (see Figure 9 schedule), the SI Test Lead will allocate the MPANs with the required data condition for routing. The DIP and the Test Target System will need to be aligned on the MPANs used.

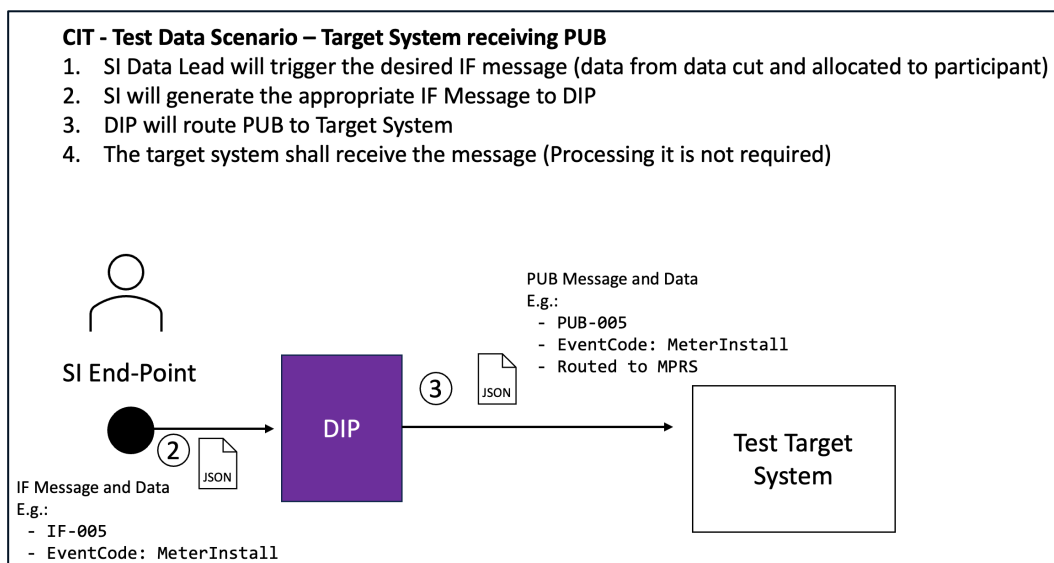

Figure 3 – Test Data Scenario – Receiving PUB

7.4 Test Data Approach – Generating IF Scenarios

Figure 4 contains the workflow where the Participant starts the test scenario from their system endpoint.

1. **Test Requirement:** Where the test scenario involves a service generating an IF, it is up to that service to generate a message appropriately, triggering it from the same point in their service as would be the case in the E2E business process (i.e. not just from their adaptor layer)
2. **Test Data:**
 - Test Data loaded on participant system from data cut.
 - Each Test Scenario contains the DIP Interface (IF) being tested.
 - The Data structure and mandatory fields are described in [REF-06] MHHSP-DES138-Interface Catalogue.
 - The participant needs to trigger the message from the same point in their service as would be the case in the E2E business process.

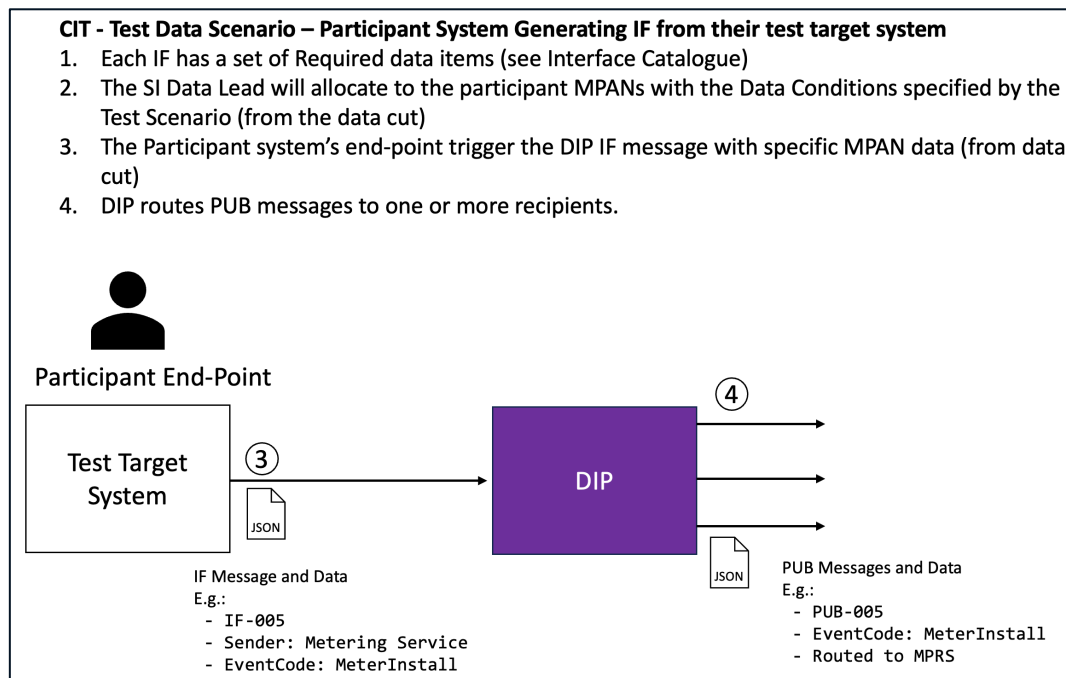

Figure 4 – Test Data Scenario – Participant's system starts the test

7.5 Test Data Approach – PUB messages trigger IF

Figure 5 contains the workflow for when the Test Scenario involves the participant to trigger the IF from a PUB message.

Where a Test Scenario has a service to respond to a PUB with the generation of an IF (for example, IF-005 being sent by a Metering Service then coming to the Registration Service as PUB-005 and the Registration Service responding by producing a corresponding IF-006), in this case, the test could be triggered by the SI Test Team sending an IF-005.

NOTE:

- The SI will trigger the initial IF using data allocated from the Data Cut and making sure the target system contains the same references to MPANs.
- If the participant's target system, during the execution of CIT tests, is not ready to trigger the IF message from the point of receiving the PUB message, the participant can trigger the IF message using another means. I.e., the IF message does not need to be synchronously generated to respond to a PUB message.

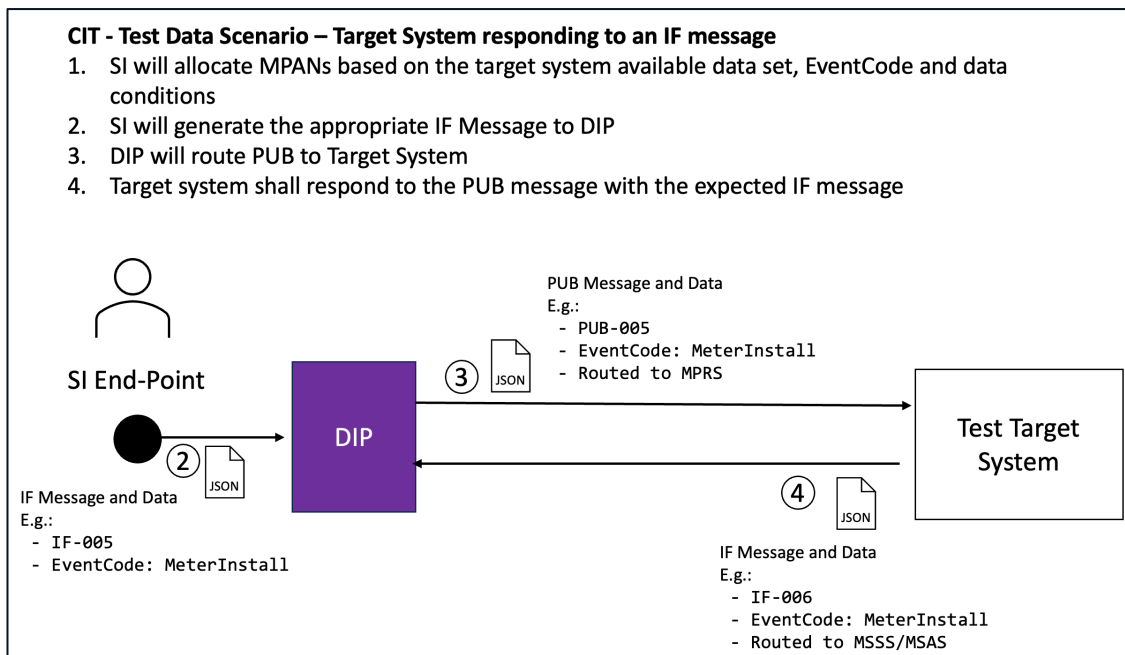

Figure 5 – Test Scenario – Responding to PUB

7.6 Test Data Preparation - Interval 1 - BSC Central Services (LSS, MDS)

Industry Standing Data (ISD):

1. ECS will have to populate the new ECS Systems with data extracted from the Data Cut such that it aligns with the MPANs taken in the MPRS data cut.
2. ECS will have to populate the new ECS Systems with appropriate Market Participant ID and their respective DIP ID generated from DIP onboarding process.
3. ECS Systems to inform SI Data Lead which Industry Standing Data items are not present.
4. SI Data Lead will generate test values for the new/missing mandatory ISD data items.
5. SI Data Lead to share Industry Standing Data items with all PPs.
6. PPs to load Industry Standing Data to their respective systems on the Test Environments.
7. As part of the Tests, the ECS will send an IF-047 to DIP that will broadcast the equivalent PUB-047 to all participant's systems.
8. The IF/PUB-047, as part of its Test Scenario, shall contain a valid link to the ISD. During the tests, the recipient participants shall demonstrate they can access and download the ISD content from the link. The recipient participants do **not** need to process the ISD as part of CIT Tests.

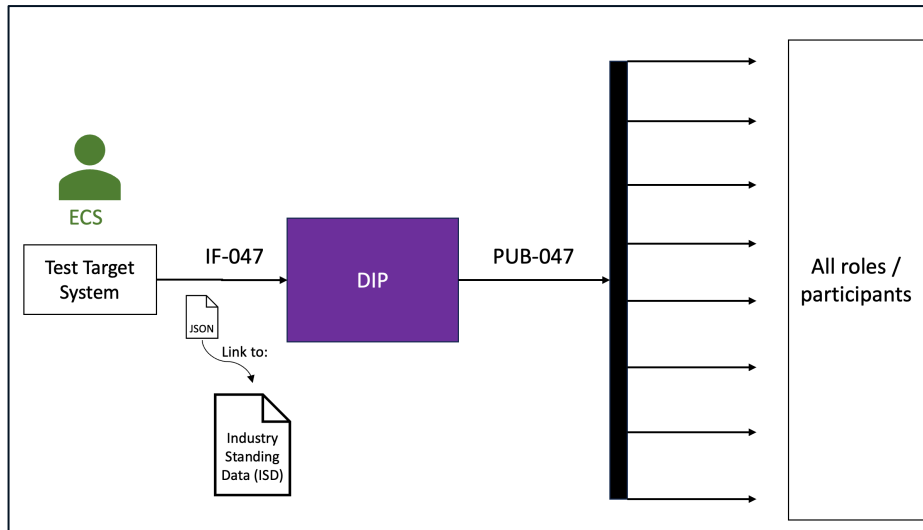

Figure 6 – ISD IF-047- Broadcast

LSS, MDS:

- contains the interfaces, Event Code and Data Conditions used by BSC Systems.
- The test data required by each interface is described on the interface catalogue.

Table 1: BSC – Required Interfaces, Event Code and Data Conditions

| Interface | Event Code | Data Conditions | Sender |
|--------------|------------------------|-----------------|--------|
| MHHSP-IF-013 | Active Power Defaulted | DI-015 = W | MDS |
| MHHSP-IF-014 | Active Power Rejected | DI-015 <> W | MDS |
| MHHSP-IF-014 | Active Power Rejected | DI-015 = W | MDS |
| MHHSP-IF-022 | LSS Period Data | | LSS |
| MHHSP-IF-023 | LSS Totals Data | | LSS |
| MHHSP-IF-040 | Annual Consumption | | MDS |
| MHHSP-IF-047 | ISD | | ISD |

7.7 Test Data Preparation – Intervals 2 and 6 – MPRS

Table 2 describes the interfaces, event code and data conditions required by CIT Scenarios for Registration service. Any data manufactured or loaded from data cut will need to meet the interface data structure, mandatory fields and data conditions set by the test scenario in execution.

Table 2 – MPRS Interfaces and Data Conditions

| Interface | Event Code | Data Conditions | Sender |
|--------------|----------------------|---------------------------------------|--------|
| MHHSP-IF-001 | Change of Supplier | | REGS |
| MHHSP-IF-001 | Initial Registration | | REGS |
| MHHSP-IF-002 | Gain MPAN info | | REGS |
| MHHSP-IF-006 | Meter Install | B033 DI-057 < SUPC.SSD + DI-979<>'R' | REGS |
| MHHSP-IF-006 | Meter Install | B033 DI-057 >= SUPC.SSD + DI-979<>'R' | REGS |
| MHHSP-IF-006 | Meter Install | B033 DI-057 < ADSC.SSD + DI-979<>'R' | REGS |
| MHHSP-IF-006 | Meter Install | B033 DI-057 >= ADSC.SSD + DI-979<>'R' | REGS |
| MHHSP-IF-006 | Meter Install | B033 DI-057 < SDSC.SSD + DI-979<>'R' | REGS |

| Interface | Event Code | Data Conditions | Sender |
|--------------|----------------------------|---------------------------------------|--------|
| MHHSP-IF-006 | Meter Install | B033 DI-057 >= SDSC.SSD + DI-979<>'R' | REGS |
| MHHSP-IF-006 | Meter Removal | B039 DI-058 < SUPC.SSD + DI-979<>'R' | REGS |
| MHHSP-IF-006 | Meter Removal | B039 DI-058 >= SUPC.SSD + DI-979<>'R' | REGS |
| MHHSP-IF-006 | Meter Removal | B039 DI-058 < ADSC.SSD + DI-979<>'R' | REGS |
| MHHSP-IF-006 | Meter Removal | B039 DI-058 >= ADSC.SSD + DI-979<>'R' | REGS |
| MHHSP-IF-006 | Meter Removal | B039 DI-058 < SDSC.SSD + DI-979<>'R' | REGS |
| MHHSP-IF-006 | Meter Removal | B039 DI-058 >= SDSC.SSD + DI-979<>'R' | REGS |
| MHHSP-IF-006 | Meter Removal | B039 DI-058 < ADSC.SSD + DI-979<>'R' | REGS |
| MHHSP-IF-006 | Meter Exchange | B033 DI-057 < SUPC.SSD + DI-979<>'R' | REGS |
| MHHSP-IF-006 | Meter Exchange | B039 DI-058 < SUPC.SSD + DI-979<>'R' | REGS |
| MHHSP-IF-006 | Meter Exchange | B033 DI-057 >= SUPC.SSD + DI-979<>'R' | REGS |
| MHHSP-IF-006 | Meter Exchange | B039 DI-058 >= SUPC.SSD + DI-979<>'R' | REGS |
| MHHSP-IF-006 | Meter Exchange | B033 DI-057 < ADSC.SSD + DI-979<>'R' | REGS |
| MHHSP-IF-006 | Meter Exchange | B039 DI-058 < ADSC.SSD + DI-979<>'R' | REGS |
| MHHSP-IF-006 | Meter Exchange | B033 DI-057 >= ADSC.SSD + DI-979<>'R' | REGS |
| MHHSP-IF-006 | Meter Exchange | B039 DI-058 >= ADSC.SSD + DI-979<>'R' | REGS |
| MHHSP-IF-006 | Meter Exchange | B033 DI-057 < SDSC.SSD + DI-979<>'R' | REGS |
| MHHSP-IF-006 | Meter Exchange | B039 DI-058 < SDSC.SSD + DI-979<>'R' | REGS |
| MHHSP-IF-006 | Meter Exchange | B033 DI-057 >= SDSC.SSD + DI-979<>'R' | REGS |
| MHHSP-IF-006 | Meter Exchange | B039 DI-058 >= SDSC.SSD + DI-979<>'R' | REGS |
| MHHSP-IF-006 | Meter Update | B033 DI-057 < SUPC.SSD + DI-979<>'R' | REGS |
| MHHSP-IF-006 | Meter Install | DI-979<>'R' | REGS |
| MHHSP-IF-006 | Meter History Update | DI-979<>'R' | REGS |
| MHHSP-IF-006 | Meter Install | DI-979='R' | REGS |
| MHHSP-IF-006 | Meter Removal | DI-979='R' | REGS |
| MHHSP-IF-006 | Meter Exchange | DI-979='R' | REGS |
| MHHSP-IF-006 | Meter Update | DI-979='R' | REGS |
| MHHSP-IF-006 | Meter History Update | DI-979='R' | REGS |
| MHHSP-IF-008 | Energisation Status Change | DI-979 = 'A' | REGS |
| MHHSP-IF-008 | Energisation Status Change | DI-979='R' | REGS |
| MHHSP-IF-009 | MPAN Disconnection | | REGS |
| MHHSP-IF-009 | CSS DeRegistration | | REGS |
| MHHSP-IF-018 | Address Chg | | REGS |
| MHHSP-IF-018 | GSP Chg | | REGS |
| MHHSP-IF-018 | DOM PremInd | | REGS |
| MHHSP-IF-018 | DUOS Tariff DChg | | REGS |
| MHHSP-IF-018 | Energy Directions | | REGS |
| MHHSP-IF-018 | DCC Enrolment | | REGS |
| MHHSP-IF-018 | MUM Indicator | | REGS |
| MHHSP-IF-020 | LinkedImportExportCreate | | REGS |
| MHHSP-IF-020 | LinkedImportExportAdd | | REGS |
| MHHSP-IF-020 | LinkedImportExportRemove | | REGS |
| MHHSP-IF-020 | RelatedCreate | | REGS |
| MHHSP-IF-020 | RelatedAdd | | REGS |

| Interface | Event Code | Data Conditions | Sender |
|--------------|-----------------------------|--|--------|
| MHHSP-IF-020 | RelatedRemove | | REGS |
| MHHSP-IF-026 | Consent Granularity | DI-979<>'R' | REGS |
| MHHSP-IF-026 | IHD Info | DI-979<>'R' | REGS |
| MHHSP-IF-026 | SMSO | DI-979<>'R' | REGS |
| MHHSP-IF-026 | SSC | DI-979<>'R' | REGS |
| MHHSP-IF-026 | Profile Class | DI-979<>'R' | REGS |
| MHHSP-IF-026 | SSC and Profile Class | DI-979<>'R' | REGS |
| MHHSP-IF-026 | Consent Granularity | DI-979='R' | REGS |
| MHHSP-IF-026 | IHD Info | DI-979='R' | REGS |
| MHHSP-IF-026 | SMSO | DI-979='R' | REGS |
| MHHSP-IF-026 | SSC | DI-979='R' | REGS |
| MHHSP-IF-026 | Profile Class | DI-979='R' | REGS |
| MHHSP-IF-026 | SSC and Profile Class | DI-979='R' | REGS |
| MHHSP-IF-032 | MSAPP Initial Resp | | REGS |
| MHHSP-IF-032 | DSAPP Initial Resp | | REGS |
| MHHSP-IF-033 | MSAPPS Request | | REGS |
| MHHSP-IF-033 | DSAPPS Request | | REGS |
| MHHSP-IF-035 | MSAPP Accepted | | REGS |
| MHHSP-IF-035 | MSAPP Rejected | | REGS |
| MHHSP-IF-035 | MSAPP Lapsed | | REGS |
| MHHSP-IF-035 | DSAPP Accepted | | REGS |
| MHHSP-IF-035 | DSAPP Rejected | | REGS |
| MHHSP-IF-035 | DSAPP Lapsed | | REGS |
| MHHSP-IF-035 | IMS_SENDMTD | Created from copy of MSApp Accepted and DSApp Accepted | REGS |
| MHHSP-IF-035 | SDS-MDR Outcome | | REGS |
| MHHSP-IF-035 | SDS-MDR Outcome | B092.DI-979 = AC | REGS |
| MHHSP-IF-035 | SDS-MDR Outcome | B092.DI-979 = RJ | REGS |
| MHHSP-IF-035 | DCC-MDR Outcome | | REGS |
| MHHSP-IF-036 | MSAPP Active | | REGS |
| MHHSP-IF-036 | DSAPP Active | | REGS |
| MHHSP-IF-037 | MSDeAPP | | REGS |
| MHHSP-IF-037 | DSDeAPP | | REGS |
| MHHSP-IF-037 | MSDeAPP Update | | REGS |
| MHHSP-IF-037 | DSDeAPP Update | | REGS |
| MHHSP-IF-039 | Direct Contract MS ADD | DI-979='A' | REGS |
| MHHSP-IF-039 | Direct Contract DS ADD | DI-979='A' | REGS |
| MHHSP-IF-039 | Direct Contract MS ADD | DI-979='R' | REGS |
| MHHSP-IF-039 | Direct Contract DS ADD | DI-979='R' | REGS |
| MHHSP-IF-039 | Direct Contract MS Remove | | REGS |
| MHHSP-IF-039 | Direct Contract DS Remove | | REGS |
| MHHSP-IF-043 | Connection Type Change | | REGS |
| MHHSP-IF-044 | Market Segement Change | | REGS |
| MHHSP-IF-045 | Invalid Marker Segment | | REGS |
| MHHSP-IF-045 | Consent Granularity Invalid | | REGS |

| Interface | Event Code | Data Conditions | Sender |
|--------------|------------------|-----------------|--------|
| MHHSP-IF-045 | No MS Appointed | | REGS |
| MHHSP-IF-045 | No DS Appointed | | REGS |
| MHHSP-IF-050 | MPAN Creation | | REGS |
| MHHSP-IF-050 | MP Status Change | | REGS |
| MHHSP-IF-050 | GreenDeal | | REGS |

7.8 Test Data Preparation - Interval 3 – SDS and ADS

Table 3 and Table 4 contain the event code, data conditions and interfaces required by Smart and Advanced Data Service CIT Tests.

Table 3 - Smart Data Service - Interfaces and Data Conditions

| Interface | Event Code | Data Conditions | Sender |
|--------------|------------------------------------|-----------------|--------|
| MHHSP-IF-021 | Active Power | DI-015 = W | SDSS |
| MHHSP-IF-028 | Consumption Amendment | | SDSS |
| MHHSP-IF-034 | DS App SP Response | | SDSS |
| MHHSP-IF-034 | SDS MDR Update | | SDSS |
| MHHSP-IF-038 | DirectContract DS ADD | | SDSS |
| MHHSP-IF-038 | DirectContract DS REMOVE | | SDSS |
| MHHSP-IF-041 | ReadingCOS | | SDSS |
| MHHSP-IF-041 | Reading On Site | | SDSS |
| MHHSP-IF-041 | ReadingRemv | | SDSS |
| MHHSP-IF-041 | ReadingInstl | | SDSS |
| MHHSP-IF-041 | ReadingRemote | | SDSS |
| MHHSP-IF-041 | ReadingEnergisationChg, DSEstimate | | SDSS |
| MHHSP-IF-041 | DSEstimate | | SDSS |

Table 4 - Advanced Data Service interfaces and Data Conditions

| Interface | Event Code | Data Conditions | Sender |
|--------------|------------------------------------|-----------------|--------|
| MHHSP-IF-015 | Consumption Replay | | ADSS |
| MHHSP-IF-021 | Active Power | DI-015 <> W | ADSS |
| MHHSP-IF-021 | Reactive Power | | ADSS |
| MHHSP-IF-028 | Consumption Amendment | | ADSS |
| MHHSP-IF-034 | DS App SP Response | | ADSS |
| MHHSP-IF-038 | DirectContract DS ADD | | ADSS |
| MHHSP-IF-038 | DirectContract DS REMOVE | | ADSS |
| MHHSP-IF-041 | ReadingRemv | | ADSS |
| MHHSP-IF-041 | ReadingInstl | | ADSS |
| MHHSP-IF-041 | ReadingRemote | | ADSS |
| MHHSP-IF-041 | ReadingEnergisationChg, DSEstimate | | ADSS |
| MHHSP-IF-041 | DSEstimate | | ADSS |

7.9 Test Data Preparation - Interval 4 – Metering Services

Table 5 and Table 6 contain the event code, data conditions and interfaces required by metering services CIT Tests.

Table 5 – Metering Services Smart – Required Interfaces, Event Code and Data Conditions

| Interface | Event Code | Data Conditions | Sender |
|--------------|-----------------------------|-----------------|--------|
| MHHSP-IF-004 | CommsHubInfo | | MSSS |
| MHHSP-IF-005 | Meter Install | | MSSS |
| MHHSP-IF-005 | Meter Removal | | MSSS |
| MHHSP-IF-005 | Meter Exchange | | MSSS |
| MHHSP-IF-005 | Meter Update | | MSSS |
| MHHSP-IF-005 | Meter History Update | | MSSS |
| MHHSP-IF-007 | Energisation Status Change | | MSSS |
| MHHSP-IF-007 | Energisation Status Failure | | MSSS |
| MHHSP-IF-034 | MS App SP Response | | MSSS |
| MHHSP-IF-038 | DirectContract MS ADD | | MSSS |
| MHHSP-IF-038 | DirectContract MS REMOVE | | MSSS |
| MHHSP-IF-041 | MS: ReadingRemv | | MSSS |
| MHHSP-IF-041 | MS: ReadingInstl | | MSSS |
| MHHSP-IF-041 | MS: ReadingEnergisationChg | | MSSS |
| MHHSP-IF-041 | MS: ReadingOnSite | | MSSS |

Table 6 – Metering Services Advanced – Required Interfaces, Event Code and Data Conditions

| Interface | Event Code | Data Conditions | Sender |
|--------------|-----------------------------|-----------------|--------|
| MHHSP-IF-005 | Meter Install | | MSAS |
| MHHSP-IF-005 | Meter Removal | | MSAS |
| MHHSP-IF-005 | Meter Exchange | | MSAS |
| MHHSP-IF-005 | Meter Update | | MSAS |
| MHHSP-IF-005 | Meter History Update | | MSAS |
| MHHSP-IF-007 | Energisation Status Change | | MSAS |
| MHHSP-IF-007 | Energisation Status Failure | | MSAS |
| MHHSP-IF-034 | MS App SP Response | | MSAS |
| MHHSP-IF-038 | DirectContract MS ADD | | MSAS |
| MHHSP-IF-038 | DirectContract MS REMOVE | | MSAS |
| MHHSP-IF-041 | ReadingRemv | | MSAS |
| MHHSP-IF-041 | ReadingInstl | | MSAS |
| MHHSP-IF-041 | ReadingEnergisationChg | | MSAS |
| MHHSP-IF-041 | ReadingOnSite | | MSAS |

7.10 Test Data Preparation - Interval 5 – Suppliers, LDSO and UMSO

Table 7 and Table 8 contain the event code, data conditions and interfaces required by suppliers and UMSO CIT Tests.

Table 7 – Suppliers systems – Required interfaces, event code and data conditions.

| Interface | Event Code | Data Conditions | Sender |
|--------------|--------------------------|-----------------|--------|
| MHHSP-IF-004 | CommsHubInfo | | SUPS |
| MHHSP-IF-019 | LinkedImportExportCreate | | SUPS |
| MHHSP-IF-019 | LinkedImportExportAdd | | SUPS |
| MHHSP-IF-019 | LinkedImportExportRemove | | SUPS |
| MHHSP-IF-019 | RelatedCreate | | SUPS |
| MHHSP-IF-019 | RelatedAdd | | SUPS |
| MHHSP-IF-019 | RelatedRemove | | SUPS |
| MHHSP-IF-024 | SN Vacant | | SUPS |
| MHHSP-IF-024 | SN NoComms | | SUPS |
| MHHSP-IF-024 | SN RemoteEnabled | | SUPS |
| MHHSP-IF-024 | SN RemoteDisabled | | SUPS |
| MHHSP-IF-024 | SN SupplierAC | | SUPS |
| MHHSP-IF-025 | ConsentGranularity | | SUPS |
| MHHSP-IF-025 | IHDInfo | | SUPS |
| MHHSP-IF-025 | SMSO | | SUPS |
| MHHSP-IF-025 | SSC | | SUPS |
| MHHSP-IF-025 | ProfileClass | | SUPS |
| MHHSP-IF-025 | SSC and Profile Class | | SUPS |
| MHHSP-IF-027 | ConsumptionAmendment | | SUPS |
| MHHSP-IF-031 | MSApp | | SUPS |
| MHHSP-IF-031 | DSApp | | SUPS |
| MHHSP-IF-041 | ReadingCOR | | SUPS |
| MHHSP-IF-041 | ReadingCOS | | SUPS |
| MHHSP-IF-041 | SupplierAgreedCOS | | SUPS |
| MHHSP-IF-041 | ReadingOverride | | SUPS |

Table 8 – UMISO systems – Required Interfaces, event code and data conditions.

| Interface | Event Code | Data Conditions | Sender |
|--------------|-----------------------------|-----------------|--------|
| MHHSP-IF-007 | Energisation Status Change | | UMISO |
| MHHSP-IF-007 | Energisation Status Failure | | UMISO |
| MHHSP-IF-034 | MSAppSPResponse | | UMISO |
| MHHSP-IF-038 | DirectContractMSAdd | | UMISO |
| MHHSP-IF-038 | DirectContractMSRemove | | UMISO |

Note: UMISO, in practice, may never send an IF-038. However, it is in the design.

Table 9 describes the interfaces, event code and data conditions required by CIT Scenarios for LDSO systems. Any data manufactured or loaded from data cut will need to meet the interface data structure, mandatory fields and data conditions set by the test scenario in execution. For CIT, Network Operation systems will be recipient of PUB-001, PUB-006, PUB-008, PUB-009, PUB-013, PUB-014, PUB-018, PUB-021, PUB-022, PUB-023, PUB-026, PUB-036, PUB-037, PUB-043, PUB-044. The SI will trigger the relevant IF messages with data allocated in alignment with the LDSO data cut.

Table 9 – LDSO systems – Required Interfaces, event code and data conditions.

| Interface | Event Code | Data Conditions | Sender |
|--------------|---|-------------------------|--------|
| MHHSP-IF-020 | [LinkedImportExportCreate], [LinkedImportExportAdd], [LinkedImportExportRemove] | [DI-979] = "R" (Reject) | LDSO |
| MHHSP-IF-020 | [RelatedCreate], [RelatedAdd], [relatedRemove] | [DI-979] = "R" (Reject) | LDSO |

7.11 Test Data Preparation - Interval 6 – UMSDS, EES

Table 10 contains the event code, data conditions and interfaces required by Unmetered Data Service CIT Tests.

Table 10 - Unmetered Data Service – Required Interfaces, event code and data conditions.

| Interface | Event Code | Data Conditions | Sender |
|------------------|------------------------|------------------------|---------------|
| MHHSP-IF-021 | Active Power | DI-015 <> W | UDSS |
| MHHSP-IF-034 | DS App SP Response | | UDSS |
| MHHSP-IF-038 | DirectContractDSAdd | | UDSS |
| MHHSP-IF-038 | DirectContractDSRemove | | UDSS |

The EES is not a sender of any IF for CIT. However, it will be a recipient of PUB-003, PUB-006, PUB-008, PUB-009, PUB-018, PUB-020, PUB-026, PUB-036, PUB-037, PUB-039, PUB-040, PUB-043, PUB-044, PUB-047, PUB-050. Data taken from the data cut will be used to trigger the relevant IF messages to be routed to EES.

o As part of the initial population of test environments, the EES will be populated with data from the Data Cut. No refresh or data augmentation required for EES before CIT.

8 Test Data Anonymisation

Each CIT participant will be allocated a set of suitable test data for each test case in scope for their role.

All MPANs records used in testing will be allocated unique reference ID that will be used in all communications, including test results and defect logging in ADO.

Due to the MPAN being considered Personal Identifiable Information (PII), it cannot be shared outside of the System Test Environment. I.e: While the Real MPAN can be used in the IF/PUB or DTS messages transferred and processed in the test environment, it cannot be shared in communication means like email, test reports, bug triage, etc.

The programme will provide a table to all participants with Unique Ref ID for the allocated MPANs to be used in communication. For example:

- MPAN Core: 20 1234 1234 123
- Ref ID (For communications and reports): dfa4aba971c132ae07014206e6abb1c6

Note:

- The same anonymisation/obfuscation approach shall be used for Domestic and Non-Domestic participants.
- **NO real domestic consumption data will be used for SIT Tests.**
- Participants may use real non-Domestic consumption/generation to check their processes.
 - It is the responsibility of the participant to analyse the risks and impact of using real non-domestic consumption data in the test environment. The real consumption data may expose participants' business-sensitive information.

8.1 Test Data Anonymisation for Testing Reports and Test Evidence

As the MPAN is considered Personal Identifiable Information (PII) and cannot be shared in Test Reports and any evidence, logs or images attached to Azure DevOps. The participant needs to obfuscate the MPAN while keeping the ability of assurance teams to verify the content.

For Reports and Test evidences:

1. The participant shall remove or obfuscate the unique identifier digits of the MPAN – Digits 11 to 18 of the full MPAN (see Figure 7).
2. For image files, the participants can blur or overlay the unique identifier with any colour graphic shape (e.g.: a white rectangle covering the unique identifier digits).
3. The same obfuscation approach shall be applied for Domestic and Non-Domestic MPANs

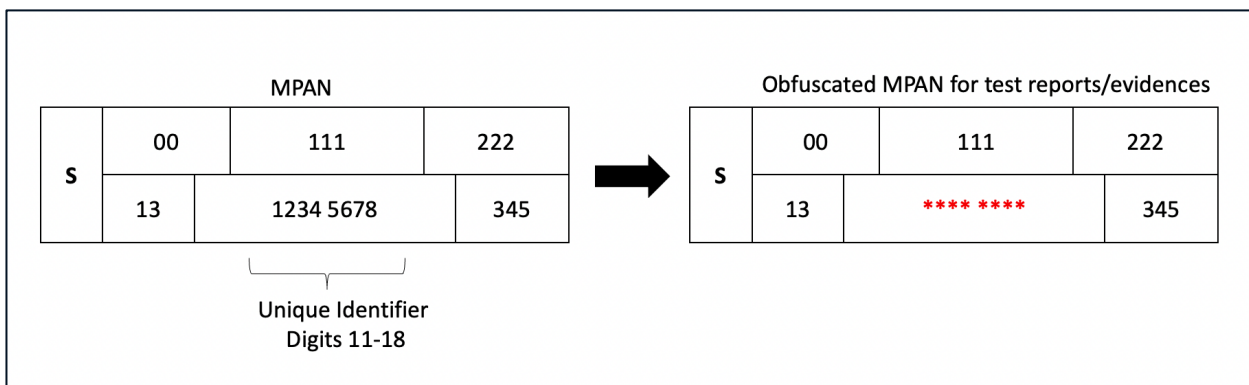

Figure 7 – MPAN obfuscation for Test Reports and evidence

9 Test Data Schedule

SIT Participants will be progressively onboarded by role / service within the CIT window as planned on [REF-02] MHHS-DEL1258 SIT Component Integration Testing Approach & Plan.

The Test Data Plan aims to provide the Test Data one month before the commencing of the respective interval.

Figure 8 and Figure 9 detail the schedule for preparing test data for each interval from the Data Cut.

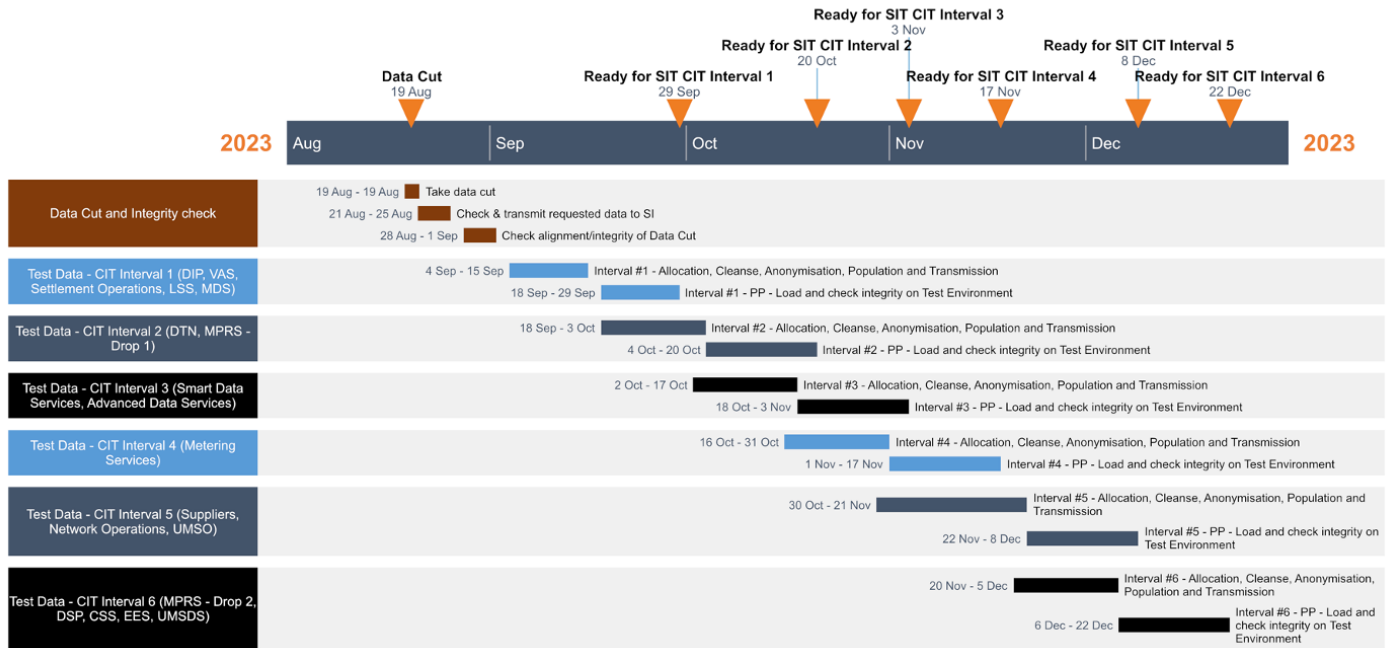

Figure 8 – SIT CIT Test Data Intervals

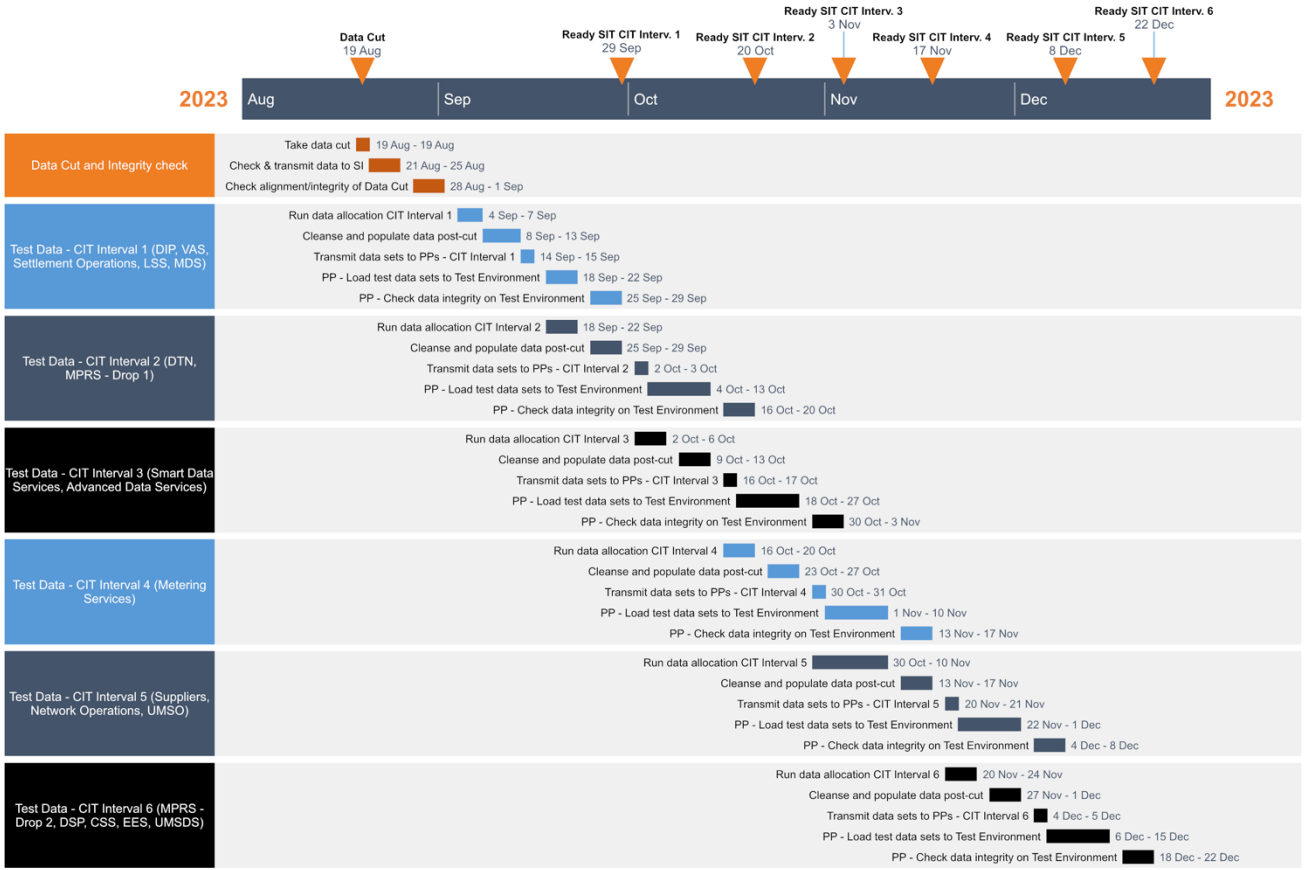

Figure 9 – SIT CIT Test Data Intervals – Detailed View

10 Appendix

N/A